



***Installation Instructions for:  
EMS P/N 30-6311  
1991-97 Mitsubishi 3000GT VR4  
1991-1997 Dodge Stealth TT***

**WARNING:**



This installation is not for the tuning novice nor the PC illiterate! Use this system with EXTREME caution! The AEM EMS System allows for total flexibility in engine tuning. Misuse of this product can destroy your engine! If you are not well versed in engine dynamics and the tuning of management systems or are not PC literate, please do not attempt the installation. Refer the installation to a AEM trained tuning shop or call 800-423-0046 for technical assistance. You should also visit the AEM EMS Tech Forum at <http://www.aempower.com>

**NOTE: AEM holds no responsibility for any engine damage that results from the misuse of this product!**

**This product is legal in California for racing vehicles only and should never be used on public highways.**

ADVANCED ENGINE MANAGEMENT INC.  
2205 126<sup>th</sup> Street Unit A Hawthorne, CA. 90250  
Phone: (310) 484-2322 Fax: (310) 484-0152  
<http://www.aempower.com>  
Instruction Part Number: 10-6311 Rev.A (Oct 2009)  
© 2009 Advanced Engine Management, Inc.

Thank you for purchasing an AEM Engine Management System.

The AEM Engine Management System (EMS) is the result of extensive development on a wide variety of cars. Each system is engineered for the particular application. The AEM EMS differs from all others in several ways. The EMS is a stand alone system, which completely replaces the factory ECU and features unique Plug and Play Technology, which means that each system is configured especially for your make and model of car without any jumper harnesses. There is no need to modify your factory wiring harness and in most cases your car may be returned to stock in a matter of minutes.

For stock and slightly modified vehicles, the supplied startup calibrations are configured to work with OEM sensors, providing a solid starting point for beginner tuning. For more heavily modified cars, the EMS can be reconfigured to utilize aftermarket sensors and has many spare inputs and outputs allowing the elimination of add-on rev-limiters, boost controllers, nitrous controllers, fuel computers, etc. It also includes a configurable onboard 1MB data logger that can record any 16 EMS parameters at up to 250 samples per second. Every EMS comes with all functions installed and activated; there is no need to purchase options or upgrades to unlock the full potential of your unit.

The installation of the AEM EMS on the supported vehicles uses the stock sensors and actuators. After installing the AEMTuner software, the startup calibration will be saved to the following folder on your PC:

*C:\Program Files\AEM\AEMTuner\Calibrations\Mitsubishi-DSM\*

Multiple calibrations may be supplied for each EMS; additional details of the test vehicle used to generate each calibration can be found in the Calibration Notes section for that file.

Please visit the AEM Performance Electronics Forum at <http://www.aempower.com> and register. We always post the most current strategy release, PC Software and startup calibrations online. On the forum, you can find and share many helpful hints/tips to make your EMS perform its best.

### **TUNING NOTES AND WARNING:**

While the supplied startup calibration may be a good starting point and can save considerable time and money, it will not replace the need to tune the EMS for your specific application. AEM startup calibrations are not intended to be driven aggressively before tuning. We strongly recommend that every EMS be tuned by someone who is already familiar with the AEM software and has successfully tuned vehicles using an AEM EMS. Most people make mistakes as part of the learning process; be warned that using your vehicle as a learning platform can damage your engine, your vehicle, and your EMS.

Read and understand these instructions **BEFORE** attempting to install this product.

### 1) Install AEMTuner software onto your PC

The latest version of the AEMTuner software can be downloaded from the AEMTuner section of the AEM Performance Electronics forums. Series 2 units are not supported by the older AEMPro tuning software.

### 2) Remove the Stock Engine Control Unit

- a) Access the stock Engine Control Unit (ECU). The location of the ECU on the 1G DSM vehicles is behind the radio in the center console.
- b) Carefully disconnect the wiring harness from the ECU. Avoid excessive stress or pulling on the wires, as this may damage the wiring harness. Some factory ECUs use a bolt to retain the factory connectors, and it must be removed before the harness can be disconnected. There may be more than one connector, and they must all be removed without damage to work properly with the AEM ECU. Do not cut any of the wires in the factory wiring harness to remove them.
- c) Remove the fasteners securing the ECU to the car body, and set them aside. Do not destroy or discard the factory ECU, as it can be reinstalled easily for street use and troubleshooting.

### 3) Install the AEM Engine Management System

- a) Plug the factory wiring harness into the AEM EMS and position it so the wires are not pulled tight or stressed in any manner. Secure the EMS with the provided Velcro fasteners.
- b) Plug the comms cable into the EMS and into your PC.
- c) Turn the ignition on but do not attempt to start the engine.
- d) The USB drivers must be installed the first time you connect to a Series 2 EMS with an onboard USB port. When the Series 2 EMS is connected to the PC's USB port and receiving power from the vehicle, the "Found New Hardware" window will appear. Select "Install from a list of specific location (Advanced)" and browse to the following folder: *C:\Program Files\AEM\AEMTuner\USB Drivers (Series 2)\*

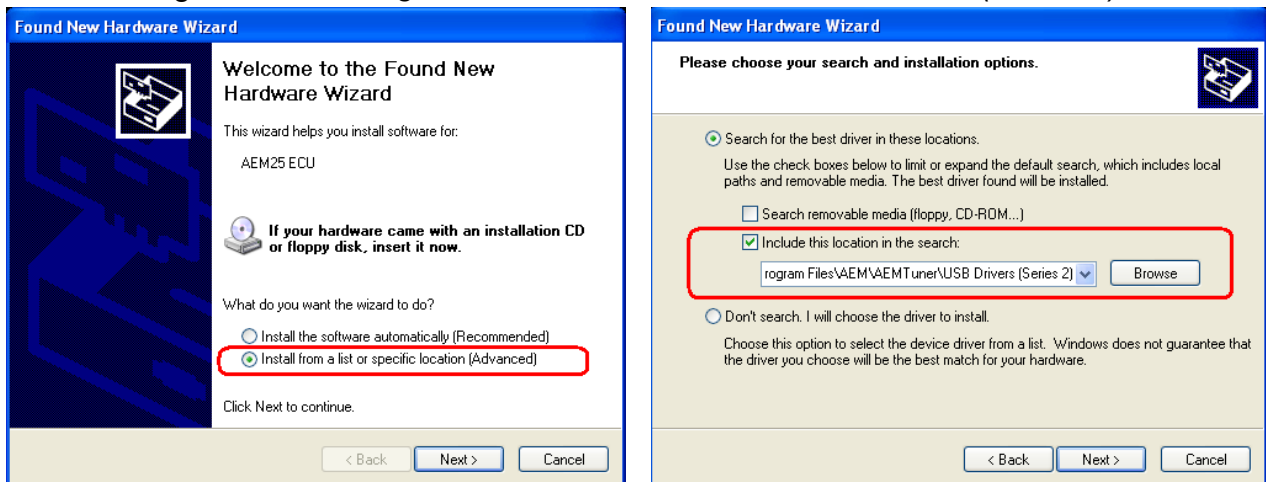

- e) With the AEMTuner software open, select **ECU>>Upload Calibration** to upload the startup calibration file (.cal) that most closely matches the vehicle's configuration to be tuned. Check the Notes section of the calibration for more info about the vehicle it was configured for. These files can be found in the following folder:  
*C:\Program Files\AEM\AEMTuner\Calibrations\Mitsubishi-DSM\*
- f) Set the throttle range: Select Wizards>>Set Throttle Range and follow the on-screen instructions. When finished, check that the 'Throttle' channel never indicates

less than 0.2% or greater than 99.8%, this is considered a sensor error and may cause some functions including idle feedback and acceleration fuel to operate incorrectly.

#### 4) Ready to begin tuning the vehicle.

- a) Before starting the engine, verify that the fuel pump runs for a couple of seconds when the key is turned on and there is sufficient pressure at the fuel rail.  
If a MAP sensor is installed, check that the Engine Load indicates something near atmospheric pressure (approximately 101kPa or 0 PSI at sea level) with the key on and engine off. Press the throttle and verify that the 'Throttle' channel responds but the Engine Load channel continues to measure atmospheric pressure correctly.
- b) Start the engine and make whatever adjustments may be needed to sustain a safe and reasonably smooth idle. Verify the ignition timing: Select **Wizards>>Ignition Timing Sync** from the pull-down menu. Click the '*Lock Ignition Timing*' checkbox and set the timing to a safe and convenient value (for instance, 10 degrees BTDC). Use a timing light and compare the physical timing numbers to the timing value you selected. Use the *Sync Adjustment Increase/Decrease* buttons to make the physical reading match the timing number you selected.
- c) Note: This calibration needs to be properly tuned before driving the vehicle. It is intended for racing vehicles and may not operate smoothly at idle or part-throttle.  
**NEVER TUNE THE VEHICLE WHILE DRIVING**

#### 5) Troubleshooting an engine that will not start

- a) Double-check all the basics first... engines need air, fuel, compression, and a correctly-timed spark event. If any of these are lacking, we suggest checking simple things first. Depending on the symptoms, it may be best to inspect fuses, sufficient battery voltage, properly mated wiring connectors, spark using a timing light or by removing the spark plug, wiring continuity tests, measure ECU pinout voltages, replace recently-added or untested components with known-good spares. Check that all EMS sensor inputs measure realistic temperature and/or pressure values.
- b) If the EMS is not firing the coils or injectors at all, open the Start tab and look for the 'Stat Sync'd' channel to turn ON when cranking. This indicates that the EMS has detected the expected cam and crank signals; if Stat Sync'd does not turn on, monitor the Crank Tooth Period and T2PER channels which indicate the time between pulses on the Crank and T2 (Cam) signals. Both of these channels should respond when the engine is cranking, if either signal is not being detected or measuring an incorrect number of pulses per engine cycle the EMS will not fire the coils or injectors.
- c) If the Engine Load changes when the throttle is pressed this usually indicates that there is a problem with the MAP sensor wiring or software calibration (when the EMS detects that the MAP Volts are above or below the min/max limits it will run in a failsafe mode using the TPS-to-Load table to generate an artificial Engine Load signal using the Throttle input). This may allow the engine to sputter or start but not continue running properly.

# Application Notes for EMS P/N 30-6311 1991-1997 3000GT VR4 / Stealth TT

Make:	Mitsubishi/Dodge
Model:	3000GT VR4 / Stealth TT
Years Covered:	1991 – 1997
Engine Displacement:	3.0L
Engine Configuration:	V6
Firing Order:	1-2-3-4-5-6
N/A, S/C or T/C:	Turbocharged
Load Sensor Type:	Karman Vortex MAF
# Coils:	3 (wasted spark)
Ignition driver type:	0-5V, Falling Edge trigger
# Injectors:	6 (P&H drivers: Inj1-6)
Injector Flow Rate:	370 cc/min
Injector Resistance:	2.3 Ω
Factory Inj Resistors:	Yes
Injection Mode:	Sequential
Knock Sensors used:	1
Lambda Sensors used:	2 (aftermarket wideband: factory O2 not supported)
Idle Motor Type:	Stepper
Main Relay Control:	Yes (Switch1 in, Coil7 out)
Crank Pickup Type:	Hall
Crank Teeth/Cycle:	6
Cam Pickup Type:	Hall
Cam Teeth/Cycle:	2
Transmissions Offered:	M/T
Trans Supported:	M/T Only
Drive Options:	AWD
Supplied Connectors:	Connector B, spare pins
Plug-N-Pin kit:	AEM part# 35-2611 (includes plugs A-D, pins)

Spare Injector Drivers:	Inj 7, Pin 116
Spare Injector Drivers:	Inj 8, Pin 6
Spare Injector Drivers:	Inj 9, Pin 83
Spare Injector Drivers:	Inj 10, Pin 105
Spare Injector Drivers:	Inj 11, Pin 89
Spare Injector Drivers:	Inj 12, Pin 104
Spare Coil Drivers:	Coil 4, Pin 91
Spare Coil Drivers:	Coil 5, Pin 82
Spare Coil Drivers:	Coil 6, Pin 85
Boost Solenoid:	PW 2, Pin 102
EGT 1 Location:	Pin 54
EGT #2 Location:	Pin 90
EGT #3 Location:	Pin 112
EGT #4 Location:	Pin 111
Spare 0-5V Channels:	MAF, Pin 59
Spare 0-5V Channels:	ADCR12, Pin 65
Spare Low Side Driver:	Low Side 1, Pin 109
Spare Low Side Driver:	Low Side 2, Pin 21
Spare Low Side Driver:	Low Side 3, Pin 71
Spare Low Side Driver:	Low Side 4, Pin 9
Spare Low Side Driver:	Low Side 5, Pin 90
Spare Low Side Driver:	Low Side 9, Pin 20
Check Engine Light:	Low Side 10, Pin 106
Spare Switch Input:	Switch 3, Pin 24
Spare Switch Input:	Switch 4, Pin 7
Spare Switch Input:	Switch 5, Pin 107
Spare Switch Input:	Switch 6, Pin 114
A/C Switch Input:	Switch 2, Pin 115
Clutch Switch Input:	---

**Notes:**

The connector numbering convention differs between the 91-93 and 94-97 models. The numbers listed above are for the 91-93 only. Please refer to the connector face diagram below to determine the proper connector number for your year.

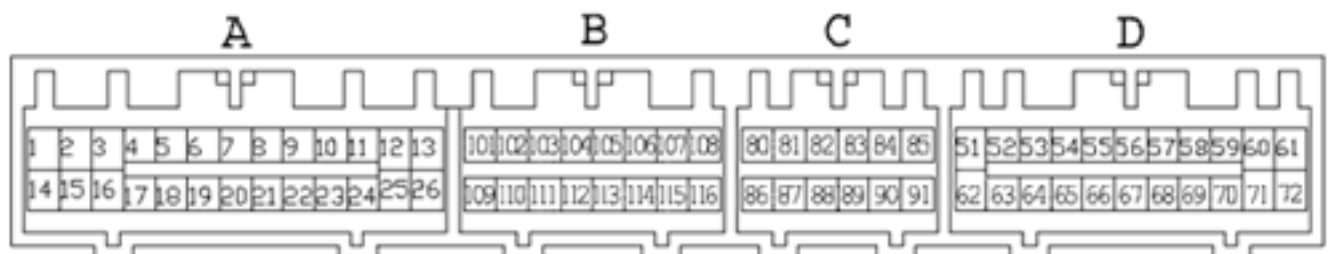

**30-1311 (91-93) AS VIEWED FROM END OF EMS**

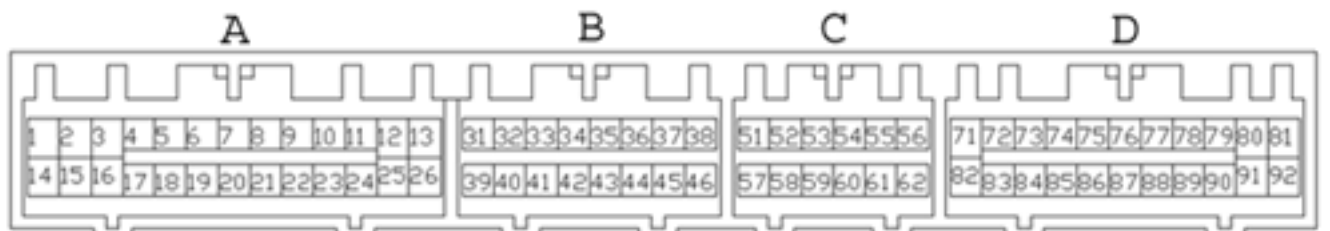

**30-1311 (94-97) AS VIEWED FROM END OF EMS**

## **WARNING:**

\* The factory A/C request switch sends 12V power to signal an A/C request and the 30-6311 EMS has been designed to accept 12V power on this switched input. If users desire to re-wire a new switch to trigger the Switch 2 input the switch should connect to 12V power when the switch is on. The pin can be left floating (disconnected) when the switch is off, it is not required to send ground to this pin.

\*\*All other switch input pins must connect to ground; the switch should not provide 12V power to the EMS because that will not be detected as on or off. Connecting 12V power to the Switch 3, Switch 4 or Switch 5 pins may damage your EMS and void your warranty.

Wiring harness destinations for non-USDM vehicles may be different than listed in the pinout charts below. If installing this EMS on a vehicle not originally sold in the US, please verify that the vehicle's wiring harness matches the pinout shown here.

The function of the following pins have been changed from the original 30-1311 EMS, please see pinout chart for more info:

80(51), 81(52), 82 (53), 85(56), 89(60), 90(61), 91(62), 104(34), 114(44)

## **Primary Load Sensor, EMS Fuel Strategy**

The factory MAF (mass air flow) sensor can be removed to help decrease intake air restriction; the EMS can be configured to use a MAP sensor to determine engine load. It is recommended to use a 3.5 bar MAP sensor or higher (P/N 30-2130-50). Please be aware that the IAT (intake air temperature) sensor is integrated into the factory MAF sensor. If the factory MAF / IAT sensor is removed, you may wish to install an AEM IAT Sensor Kit (P/N 30-2010), which includes a sensor, wire connector, and aluminum weld-in bung. While the factory MAF sensor locates the IAT sensor upstream of the turbocharger inlet, it may be preferable to install an IAT sensor downstream of the intercooler to accurately measure charge temperatures.

The factory Mass Air Flow and Intake Air Temperature sensors can be used as the primary load input for the AEM EMS if desired. Please check the Notes section of each calibration for more info about the vehicle setup and fuel strategy that calibration was configured to use.

## **EMS Fuel Map, Boost Fuel Trim Table**

The 30-6311 maps provided utilize the "*Boost Fuel Trim Table*" to provide a 1:1 fuel compensation above and below atmospheric pressure. In the startup calibration, the "*Boost Fuel Trim Table*" is configured to provide twice as much fuel when the manifold pressure is twice as high and half the fuel when the manifold pressure is half as high; this should help simplify the tuning process for different vacuum and boost levels. Notice the values in the main "*Fuel Map*" do not change above 100 kPa (0 psi boost), the fuel correction is being made by the "*Boost Fuel Trim Table*."

Note: the "*Boost Fuel Trim Table*" must be adjusted if a different MAP sensor is installed or if the Load breakpoints are adjusted. The Boost Fuel Correct value should be set to -90 at 10kPa, 0 at 100 kPa, +100 at 200 kPa, +200 at 300 kPa, etc...

## **Peak and Hold Injector Drivers**

Injectors 1-6 include Peak (4 amps) and Hold (1 amp) injector drivers. These drivers may be used with peak and hold or saturated type injectors. The factory Mitsubishi wiring harness contains a resistor pack to prevent excessive current when using low-impedance injectors with the stock ECU. With the 30-6311 installed, users can elect to remove and bypass the OEM resistor pack for more precise control of low-impedance injectors.

Please note that the injector response time will be different with and without the factory injector resistor pack. If the OEM resistor pack has been removed and bypassed, please choose the correct battery offset for your injectors using the Setup Wizard. Most battery offset wizard configurations will specify <P&H DRIVER> if they are intended for use without a resistor pack.

## **Unused accessories:**

The EMS does not support the Active Exhaust found on the 91-93 models. If you still have this, it must be disconnected from the ECU (pin 102). If not disconnected, a whirring noise will be heard from the AE drive motor located in the left rear quarter panel on the car. While this causes no damage, it is quite annoying.

The stock "boost" gauge is not used.

## **Wiring accessories to the EMS:**

Please follow this suggested wiring diagram when adding accessories such as UEGO gauges, MAP sensors, IAT sensors, or switches for use with the EMS. Note that wire polarity is not important for the Air Temperature sensor.

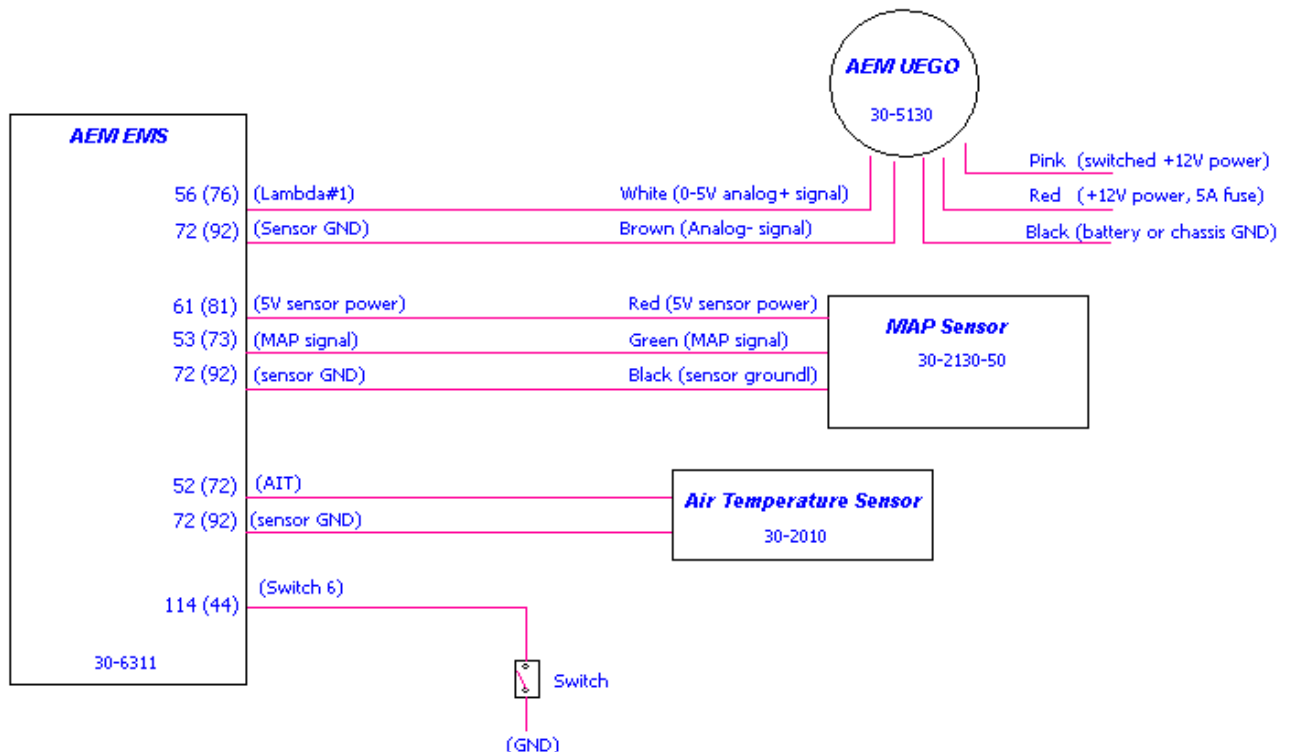

# Connection Diagram for EMS P/N 30-6311

## 1991-97 Mitsubishi 3000GT VR4, Dodge Stealth TT

PnP Means the Plug and Play system comes with this configured for proper operation of this device. Is still available for reassignment by the end user.

Avail Means the function is not currently allocated and is available for use

Dedicated Means the location is fixed and cant be changed

91-93	94-97						
Pin	Pin	91-93 3000 GT	94-97 3000 GT	AEM EMS 30-6311	I/O	91-93 Notes	94-97 Notes
1	1	Injector 1	<---	Injector 1 P&H	Output	Injector 1 (Peak/Hold 4A/1A driver)	<--
2	2	Injector 3	<---	Injector 3 P&H	Output	Injector 3 (Peak/Hold 4A/1A driver)	<--
3	3	Injector 5	<---	Injector 5 P&H	Output	Injector 5 (Peak/Hold 4A/1A driver)	<--
4	4	Idle Speed Control Servo (pin 1)	<---	Idle 1	Output	PnP for Stepper Idle Motor	<--
5	5	Idle Speed Control Servo (pin 4)	<---	Idle 3	Output	PnP for Stepper Idle Motor	<--
6	6	EGR Solenoid Valve	<---	Injector 8	Output	Avail, Switched Ground, 1.5A max	<--
7	7	Fuel Pressure Solenoid	<---	Switch 4	Input	Avail, switch must connect to ground	<--
8	8	MFI Relay (fuel pump)	<---	Low Side 11	Output	PnP for Fuel Pump relay	<--
9	9	EVAP Purge Solenoid Valve	<---	Low Side 4	Output	Avail, Switched Ground, 1.5A max	<--
10	10	Ignition Power Transistor (1&4)	<---	Coil 1	Output	PnP for Coil 1, rising edge trigger	<--
11	11	Ignition Power Transistor (3&6)	<---	Coil 3	Output	PnP for Coil 3, rising edge trigger	<--
12	12	MFI Relay Power IN (main)	<---	+12V Switched	Input	Dedicated, +12V when relay is on	<--
13	13	Ground	<---	Ground	Input	Dedicated	<--
14	14	Injector 2	<---	Injector 2 P&H	Output	Injector 2 (Peak/Hold 4A/1A driver)	<--
15	15	Injector 4	<---	Injector 4 P&H	Output	Injector 4 (Peak/Hold 4A/1A driver)	<--
16	16	Injector 6	<---	Injector 6 P&H	Output	Injector 6 (Peak/Hold 4A/1A driver)	<--
17	17	Idle Speed Control Servo (pin 3)	<---	Idle 2	Output	PnP for Stepper Idle Motor	<--
18	18	Idle Speed Control Servo (pin 6)	<---	Idle 4	Output	PnP for Stepper Idle Motor	<--
19	19	Maf reset switch	<---	Low Side 8	Output	Avail, Switched Ground, 1.5A max	<--
20	20	A/C clutch slip input	Rad Fan High	Low Side 9	Output	Avail, Switched Ground, 1.5A max	Rad Fan 2
21	21	Fuel Pump Relay (low speed)	Rad Fan Low	Low Side 2	Output	Avail, Switched Ground, 1.5A max	Rad Fan 1
22	22	Magnetic Clutch Relay	<---	Low Side 6	Output	PnP for A/C Compressor	<--
23	23	Ignition Power Transistor (2&5)	<---	Coil 2	Output	PnP for Coil 2, rising edge trigger	<--
24	24	Electrical Load (input)	<---	Switch 3	Input	Avail, switch must connect to ground	<--
25	25	MFI Relay Power IN (main)	<---	+12V Switched	Input	Dedicated, +12V when relay is on	<--
26	26	Ground (in)	<---	Ground	Input	Dedicated	<--

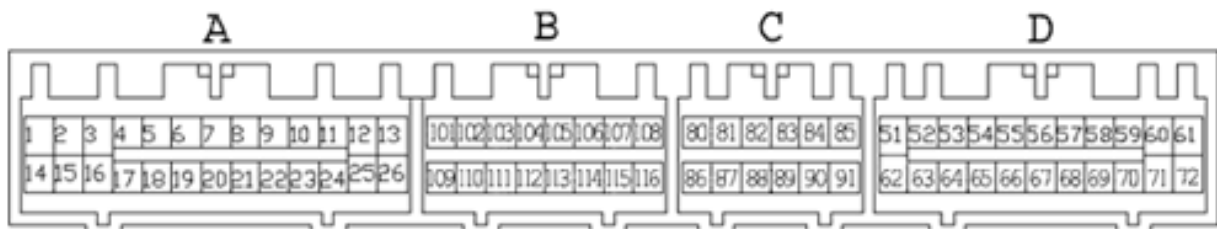

30-1311 (91-93) AS VIEWED FROM END OF EMS

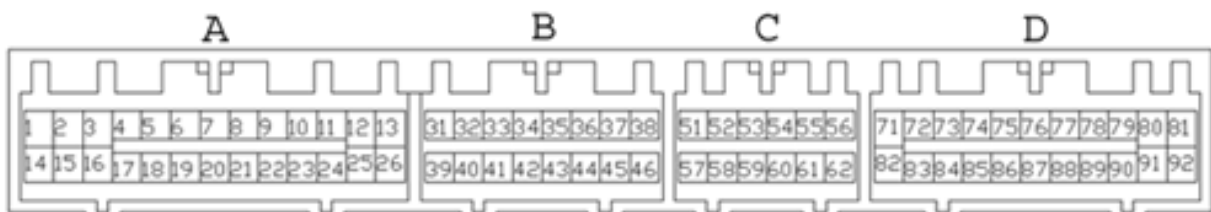

30-1311 (94-97) AS VIEWED FROM END OF EMS

91-93	94-97	91-93 3000 GT	94-97 3000 GT	AEM EMS 30-6311	I/O	91-93 Notes	94-97 Notes
101	31	Ignition OK input	Fuel Pump Relay (Low)	Not Used	---	---	---
102	32	Active Exhaust*	Wastegate Solenoid*	PW 2	Output	PnP for Wastegate Control Solenoid	<--
103	33	Active Exhaust Switch	---	Not Used	---	---	---
104	34	Timing Adjust Connector	Active Exh / LF O2 Heater	Injector 12	Output	Avail, Inj output 1.5A max (not P&H)	<--
105	35	Wastegate Solenoid*	RF O2 Heater*	PW 2	Output	PnP for Wastegate Control Solenoid	<--
106	36	Check Engine	<---	Low Side 10	Output	PnP for 7,000 RPM Shift Light	<--
107	37	PS Press. Switch	<---	Switch 5	Input	Avail, switch must connect to ground	<--
108	38	MFI Relay Control	<---	Main Relay (Coil7)	Output	Dedicated, switched GND to relay	<--
109	39	---	Boost Gauge (96-97)	Low Side 1	Output	Avail, Switched Ground driver	<--
110	40	---	Fuel Pressure Sol (96-97)	---	---	---	---
111	41	Boost Gauge	Boost Gauge (94-95)	EGT4 (ADCR16)	Input	Avail, jumper set for 0-5V Input	<--
112	42	Data Link Connector	LR O2 Heater (96-97)	EGT3 (ADCR15)	Input	Avail, jumper set for 0-5V Input	<--
113	43	Data Link Connector	RR O2 Heater (96-97)	High Side 4	Output	Avail, Switched 12v, 1.5A max	<--
114	44	ABS Control	<---	Switch 6	Input	Avail, switch must connect to ground	<--
115	45	Magnetic Clutch	<---	Switch 2	Input	PnP for A/C request switch	<--
116	46	---	---	Injector 7	Output	Avail, Inj output 1.5A max (not P&H)	<--
91-93	94-97	91-93 3000 GT	94-97 3000 GT	AEM EMS 30-6311	I/O	91-93 Notes	94-97 Notes
80	51	---	---	Low Side 3	Output	Avail, Switched Ground, 1.5A max	<--
81	52	---	Ign. Timing Adj	Coil 3	Output	PnP for Coil 3, rising edge trigger (connects to pin 11)	<--
82	53	---	---	Coil 5	Output	Avail, 0-5V rising edge trigger	<--
83	54	---	---	Injector 9	Output	Avail, Inj output 1.5A max (not P&H)	<--
84	55	---	---	Low Side 5	Output	Avail, Switched Ground, 1.5A max	<--
85	56	---	Data Link Connector	Coil 6	Output	Avail, 0-5V rising edge trigger	<--
86	57	---	---	Idle 7	Output	Avail, Ground / +12V, 1.5A max	<--
87	58	---	Ignition OK input	Not Used	---	---	---
88	59	---	A/C clutch slip input	Low Side 12	Output	Avail, Switched Ground, 1.5A max	<--
89	60	---	Right O2 Sensor Rear (Cal)	Injector 11	Output	Avail, Inj output 1.5A max (not P&H)	<--
90	61	---	---	EGT2	Input	Avail, jumper set for 0-5V Input	<--
91	62	---	Data Link Connector	Coil 4	Output	Avail, 0-5V rising edge trigger	<--

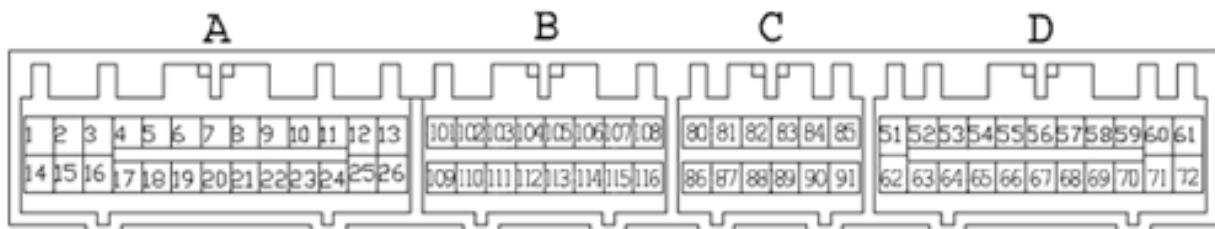

30-1311 (91-93) AS VIEWED FROM END OF EMS

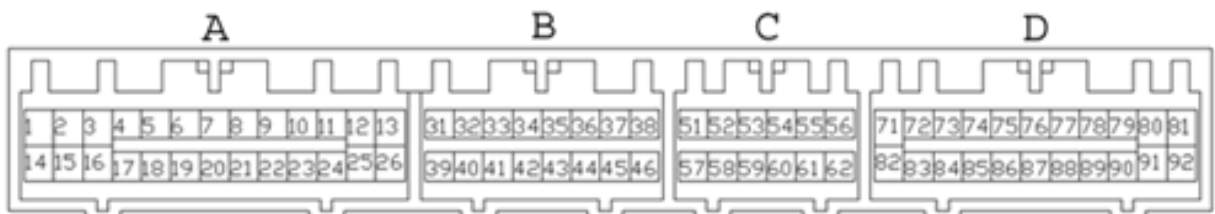

30-1311 (94-97) AS VIEWED FROM END OF EMS

91-93	94-97	91-93 3000 GT	94-97 3000 GT	AEM EMS 30-6311	I/O	91-93 Notes	94-97 Notes
51	71	Starter Signal	<---	Main Relay (Start sw)	Input	Dedicated, activates Switch 1 input	<--
52	72	Intake Air Temp Sensor	<---	AIT	Input	Dedicated, 2.2k ohm pull-up to 5V	<--
53	73	EGR Temp Sensor	Right O2 Rear (96-97)	MAP	Input	Avail, 0-5V MAP sensor input	<--
54	74	---	Manifold Diff Press (96-97)	EGT #1	Input	Avail, jumper set for 0-5V Input	<--
55	75	Right Bank O2 Sensor	<---	O2 #2	Input	Dedicated, 0-5V signal	<--
56	76	Left Bank O2 Sensor	<---	O2 #1	Input	Dedicated, 0-5V signal	<--
57	77	---	---	CAN1L	---	Dedicated	<--
58	78	Knock Sensor	<---	Knock #1	Input	Dedicated, software knock filter	<--
59	79	---	Left O2 Sensor Rear (Cal)	MAF	Input	Available, 0-5V sensor input	<--
60	80	Battery Back Up	<---	Permanent +12V	Input	Dedicated, used to store internal log	<--
61	81	5V sensor reference power	<---	+5V Sensor	Output	Dedicated, sensors only	<--
62	82	Ignition Switch	<---	Main Relay (Ign sw)	Input	Dedicated, activates Switch 1 input	<--
63	83	Engine Coolant Temp. Sensor	<---	Coolant	Input	Dedicated, 2.2k ohm pull-up to 5V	<--
64	84	Throttle Position Sensor	<---	TPS	Input	Dedicated, 100k ohm pull-up to 5V	<--
65	85	Atmospheric Press. Sensor	<---	Baro Volts	Input	Available, 0-5V sensor input	<--
66	86	Vehicle Speed Sensor	<---	T3 (Vehicle Speed)	Input	PnP for Vehicle Speed Sensor	<--
67	87	Throttle Position Switch	<---	CAN1H	---	Dedicated	<--
68	88	Camshaft Position Sensor	<---	Cam	Input	Dedicated, Camshaft sensor	<--
69	89	Crankshaft Position Sensor	<---	Crank	Input	Dedicated, Crankshaft sensor	<--
70	90	Volume Air Flow Sensor	<---	T4 (Spare Speed)	Input	PnP for frequency MAF input	<--
71	91	Ground	<---	Ground	Input	Dedicated	<--
72	92	Sensor Ground	<---	Sensor Ground	Output	Dedicated, sensors only	<--

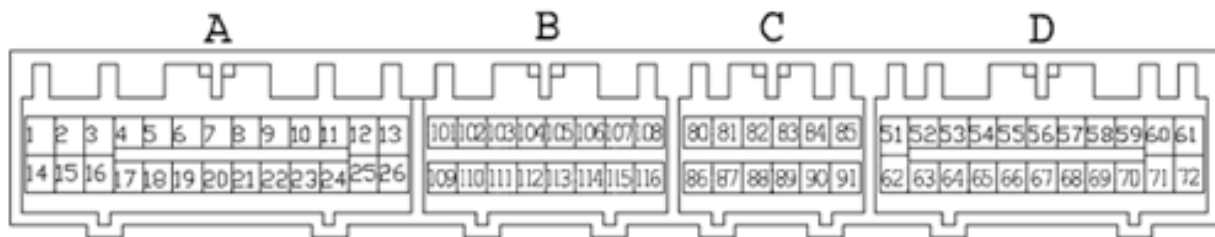

30-1311 (91-93) AS VIEWED FROM END OF EMS

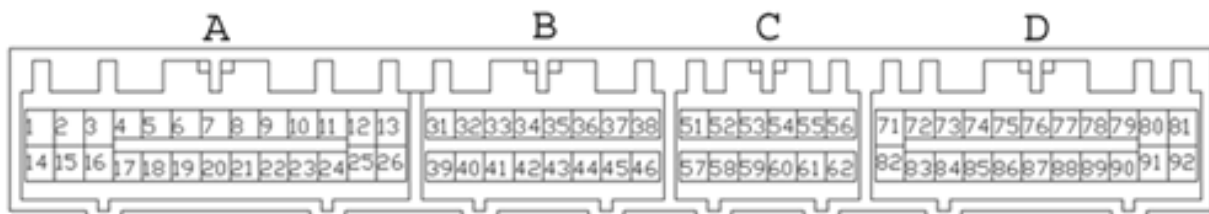

30-1311 (94-97) AS VIEWED FROM END OF EMS

**30-1311 (Series 1) vs 30-6311 (Series 2) 3000GT/Stealth EMS pin differences:**

The EMS functions assigned to certain pins have been changed and no longer match the 30-1311 EMS. Unless otherwise noted, the following pins and functions will need to be manually reconfigured after using AEMTuner to convert a V1.19 (30-1300, Series 1 EMS) calibration for use with the 30-6311 Series 2 hardware.

91-93	94-97	91 / 94 3000GT, Stealth	30-1311 function	30-6311 function	Notes
80	51	---	---	Low Side 3	
81	52	---	PW #1i	Coil 3	connects to pin 11
82	53	---	Switch 6	Coil 5	
85	56	---	High Side #3	Coil 6	
89	60	--- / Right Rear O2 sensor	Injector #9	Injector 11	Inj 9 available on pin 83 (54)
90	61	---	ADCR11	EGT 2	
91	62	--- / Data Link Connector	FM	Coil 4	
104	34	Timing Adj. / LF O2 heater	Injector #10	Injector 12	PCB jumper change req'd for Inj10
114	44	ABS Control / ---	EGT 2	Switch 6	EGT 2 available on pin 90 (61)

## **AEM Electronics Warranty**

Advanced Engine Management Inc. warrants to the consumer that all AEM Electronics products will be free from defects in material and workmanship for a period of twelve months from date of the original purchase. Products that fail within this 12-month warranty period will be repaired or replaced when determined by AEM that the product failed due to defects in material or workmanship. This warranty is limited to the repair or replacement of the AEM part. In no event shall this warranty exceed the original purchase price of the AEM part nor shall AEM be responsible for special, incidental or consequential damages or cost incurred due to the failure of this product. Warranty claims to AEM must be transportation prepaid and accompanied with dated proof of purchase. This warranty applies only to the original purchaser of product and is non-transferable. All implied warranties shall be limited in duration to the said 12-month warranty period. Improper use or installation, accident, abuse, unauthorized repairs or alterations voids this warranty. AEM disclaims any liability for consequential damages due to breach of any written or implied warranty on all products manufactured by AEM. Warranty returns will only be accepted by AEM when accompanied by a valid Return Merchandise Authorization (RMA) number. Product must be received by AEM within 30 days of the date the RMA is issued.

Please note that before AEM can issue an RMA for any electronic product, it is first necessary for the installer or end user to contact the tech line at 1-800-423-0046 to discuss the problem. Most issues can be resolved over the phone. Under no circumstances should a system be returned or a RMA requested before the above process transpires.

AEM will not be responsible for electronic products that are installed incorrectly, installed in a non approved application, misused, or tampered with.

Any AEM electronics product can be returned for repair if it is out of the warranty period. There is a minimum charge of \$50.00 for inspection and diagnosis of AEM electronic parts. Parts used in the repair of AEM electronic components will be extra. AEM will provide an estimate of repairs and receive written or electronic authorization before repairs are made to the product.