

Instruction Manual



INSTALLATION INSTRUCTIONS FOR EMS P/N 30-6051

1998-1999 ACURA 2.3CL

1996-2000 HONDA CIVIC

Engine Harness Fitment:

1999-2002 Honda Accord V6 J30A1

1999 Acura CL 3.0L J30A

2001-2003 Acura CL 3.2L J32A1 (auto harness only)

1999-2003 Acura TL 3.2L J32A1

2002-2003 Acura CL/TL 3.2L Type S J32A2 (auto harness only)

2002-2004 Honda Odyssey 3.5L J35A4

STOP!

THIS PRODUCT HAS LEGAL RESTRICTIONS. **READ THIS BEFORE INSTALLING/USING!**

THIS PRODUCT MAY BE USED SOLELY ON VEHICLES USED IN SANCTIONED COMPETITION WHICH MAY NEVER BE USED UPON A PUBLIC ROAD OR HIGHWAY, UNLESS PERMITTED BY SPECIFIC REGULATORY EXEMPTION. (VISIT THE "EMISSIONS" PAGE AT [HTTP://WWW.SEMASAN.COM/EMISSIONS](http://www.semasan.com/emissions) FOR STATE BY STATE DETAILS.)

IT IS THE RESPONSIBILITY OF THE INSTALLER AND/OR USER OF THIS PRODUCT TO ENSURE THAT IT IS USED IN COMPLIANCE WITH ALL APPLICABLE LAWS AND REGULATIONS. IF THIS PRODUCT WAS PURCHASED IN ERROR, DO NOT INSTALL AND/OR USE IT. THE PURCHASER MUST ARRANGE TO RETURN THE PRODUCT FOR A FULL REFUND.

THIS POLICY ONLY APPLIES TO INSTALLERS AND/OR USERS WHO ARE LOCATED IN THE UNITED STATES; HOWEVER CUSTOMERS WHO RESIDE IN OTHER COUNTRIES SHOULD ACT IN ACCORDANCE WITH THEIR LOCAL LAWS AND REGULATIONS.

WARNING: This installation is not for the tuning novice! Use this system with **EXTREME** caution! The AEM EMS allows for total flexibility in engine tuning. Misuse or improper tuning of this product can destroy your engine! If you are not well versed in engine dynamics and the tuning of engine management systems **DO NOT** attempt the installation. Refer the installation to an AEM-trained tuning shop or call 800-423-0046 for technical assistance.

NOTE: All supplied AEM calibrations, Wizards and other tuning information are offered as potential starting points only. IT IS THE RESPONSIBILITY OF THE ENGINE TUNER TO ULTIMATELY CONFIRM IF THE CALIBRATION IS SAFE FOR ITS INTENDED USE. AEM holds no responsibility for any engine damage that results from the misuse or mistuning of this product!

Thank you for purchasing an AEM Engine Management System.

The AEM Engine Management System (EMS) is the result of extensive development on a wide variety of cars. Each system is engineered for the particular application. The AEM EMS differs from all others in several ways. The EMS is a stand alone system, which completely replaces the factory ECU and features unique Plug and Play Technology, which means that each system is configured especially for your make and model of car without any jumper harnesses. There is no need to modify your factory wiring harness and in most cases your car may be returned to stock in a matter of minutes.

For stock and slightly modified vehicles, the supplied startup calibrations are configured to work with OEM sensors, providing a solid starting point for beginner tuning. For more heavily modified cars, the EMS can be reconfigured to utilize aftermarket sensors and has many spare inputs and outputs allowing the elimination of add-on rev-limiters, boost controllers, nitrous controllers, fuel computers, etc. It also includes a configurable onboard 1MB data logger that can record any 16 EMS parameters at up to 250 samples per second. Every EMS comes with all functions installed and activated; there is no need to purchase options or upgrades to unlock the full potential of your unit.

The installation of the AEM EMS on the supported vehicles uses the stock sensors and actuators. After installing the AEMTuner software, the startup calibration will be saved to the following folder on your PC:

C:\Program Files\AEM\AEMTuner\Calibrations\Honda - Acura

Multiple calibrations may be supplied for each EMS; additional details of the test vehicle used to generate each calibration can be found in the Calibration Notes section for that file.

Please visit the AEM Performance Electronics Forum at <http://www.aempower.com> and register. We always post the most current strategy release, PC Software and startup calibrations online. On the forum, you can find and share many helpful hints/tips to make your EMS perform its best.

TUNING NOTES AND WARNING:

While the supplied startup calibration may be a good starting point and can save considerable time and money, it will not replace the need to tune the EMS for your specific application. AEM startup calibrations are not intended to be driven aggressively before tuning. We strongly recommend that every EMS be tuned by someone who is already familiar with the AEM software and has successfully tuned vehicles using an AEM EMS. Most people make mistakes as part of the learning process; be warned that using your vehicle as a learning platform can damage your engine, your vehicle, and your EMS.

Read and understand these instructions **BEFORE** attempting to install this product.

- **OE Speedometer Functionality**

Please note that the 30-6051 EMS is configured to drive the original 1996-2000 Honda Civic speedometer by outputting the appropriate signal on pin A9. This signal is calibrated to use the OE Honda Civic dashboard, replacing the OE speedometer with one from a different vehicle may change the behavior of the gauge.

- **Engine Wiring Harnesses, 'swapped' engine installations**

It would be very wise to double-check that the pinout destinations for the circuits is accurate to the provided documentation. This is especially true if the vehicle contains a 'swapped' engine or if the wiring harness has been cut, spliced, soldered, tapped or modified in any manner. It is the user's responsibility to check that the wiring on the vehicle matches the pinout chart in this document. AEM will not be held responsible for loss or damage that can occur if the EMS is installed in a vehicle in which the wiring harness does not match the AEM-supplied pinout chart!

- **EMS Fuel Map, Boost Fuel Trim Table**

The 30-6051 calibration maps provided do not utilize the "Boost Fuel Trim Table" to provide a 1:1 fuel compensation below atmospheric pressure since the calibration was created on a naturally aspirated vehicle (A calibration is provided above 100 kPa). To use this table, the "Boost Fuel Trim Table" should be configured to provide twice as much fuel when the manifold pressure is twice as high and half the fuel when the manifold pressure is half as high; this should help simplify the tuning process for different vacuum and boost levels. Notice the values in the main "Fuel Map" do not change above 100 kPa (0 psi boost), the fuel correction is being made by the "Boost Fuel Trim Table."

Note: the "Boost Fuel Trim Table" must be adjusted if a different MAP sensor is installed or if the Load breakpoints are adjusted. The Boost Fuel Trim value should be set to -90 at 10kPa, 0 at 100 kPa, +100 at 200 kPa, +200 at 300 kPa, etc...

- **AEM EMS coil/injector differences from original Honda ECU:**

The AEM EMS fires cylinders based on a different numbering scheme than the original ECU. The chart below shows how the original cylinder numbers correspond to the EMS coil/injector numbers. This is configured in the base calibration already and is shown in the pinout tables later in this document.

Vehicle cylinder number	AEM EMS injector number	AEM EMS coil number
1	1	1
2	4	4
3	5	5
4	3	3
5	2	2
6	6	6

Wiring accessories to the EMS:

Please follow this suggested wiring diagram when adding/retaining original accessories such as the speedometer, reverse lockout, UEGO gauges, MAP sensors, IAT sensors, or switches for use with the EMS. Note that wire polarity is not important for the Air Temperature sensor.

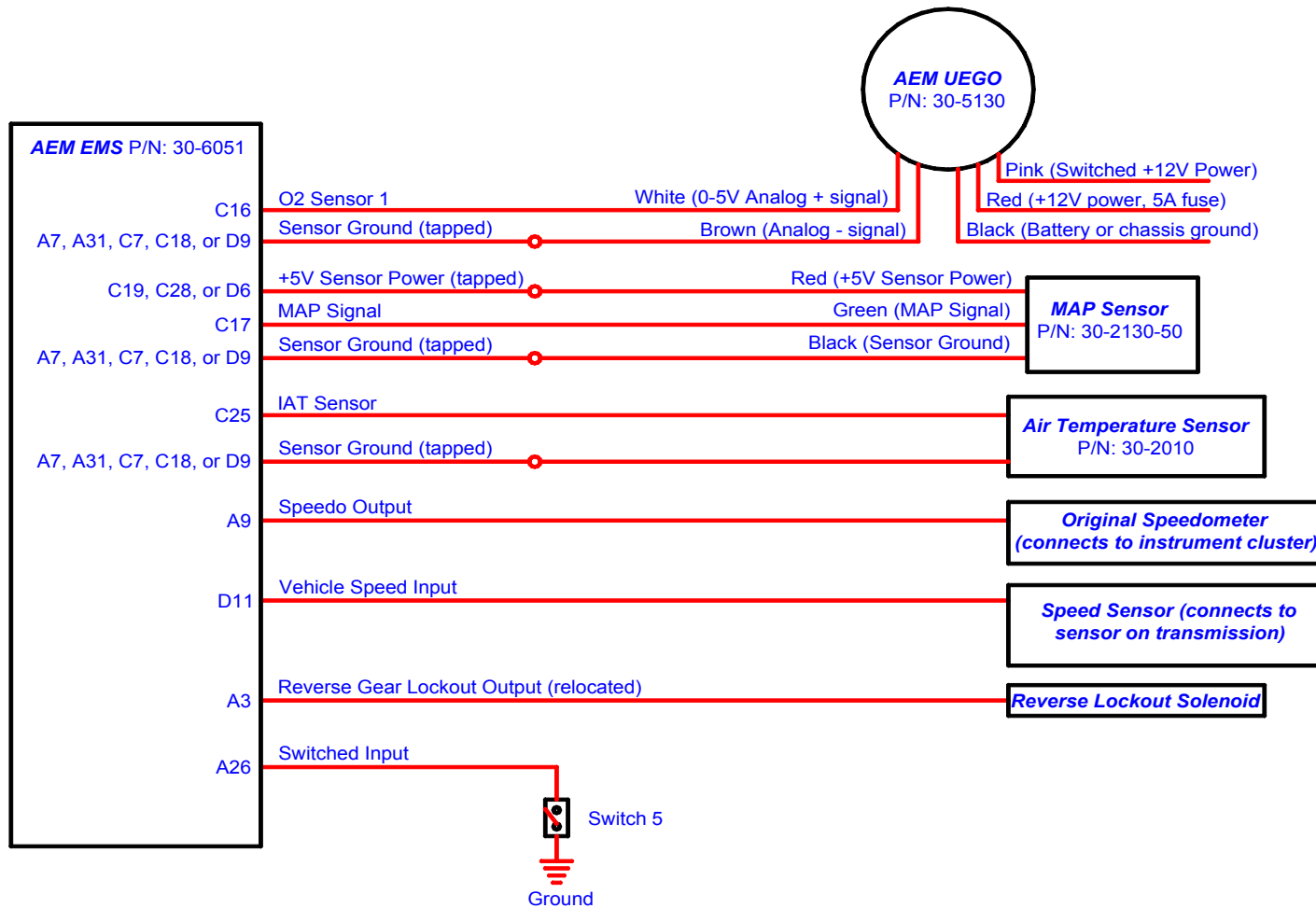

1) Install AEMTuner software onto your PC

The latest version of the AEMTuner software can be downloaded from the AEMTuner section of the AEM Performance Electronics forums. Series 2 units are not supported by the older AEMPro tuning software.

2) Remove the Stock Engine Control Unit

- a) Access the stock Engine Control Unit (ECU). The location of the ECU on Acura Integra, Acura CL/TL, Honda Accord, and Honda Civic vehicles is behind the kick-panel on the passenger side of the vehicle.
- b) Carefully disconnect the wiring harness from the ECU. Avoid excessive stress or pulling on the wires, as this may damage the wiring harness. All connectors must be removed without damage to work properly with the AEM ECU. Do not cut any of the wires in the factory wiring harness to remove them.
- c) Remove the fasteners securing the ECU to the car body, and set them aside. Do not destroy or discard the original ECU, as it can be reinstalled easily for street use and troubleshooting.

3) Repin appropriate ECU pins

- a) For this application there is the potential need to repin some ECU pins. For the tested application only one pin was added. Since there was no reverse lockout solenoid activation on the automatic wiring harness, this pin was placed on ECU connector pin A3.
- b) Locate a small screwdriver (a precision 1.5mm wide flathead screwdriver is recommended) and carefully pry white plastic retainer using both slots in the retainer so it disengages vertically about 1mm as shown in the following pictures:

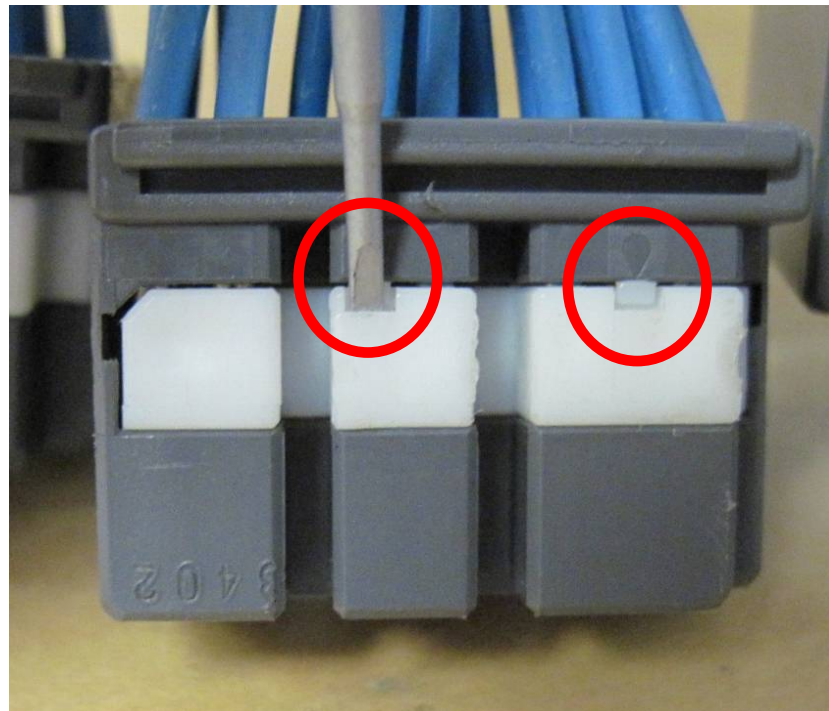

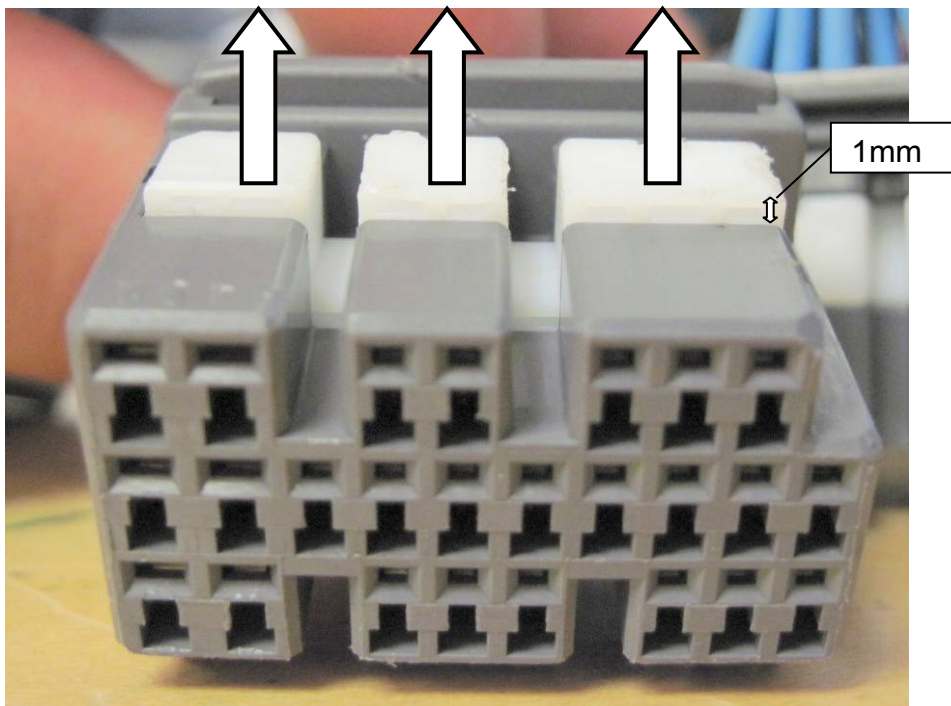
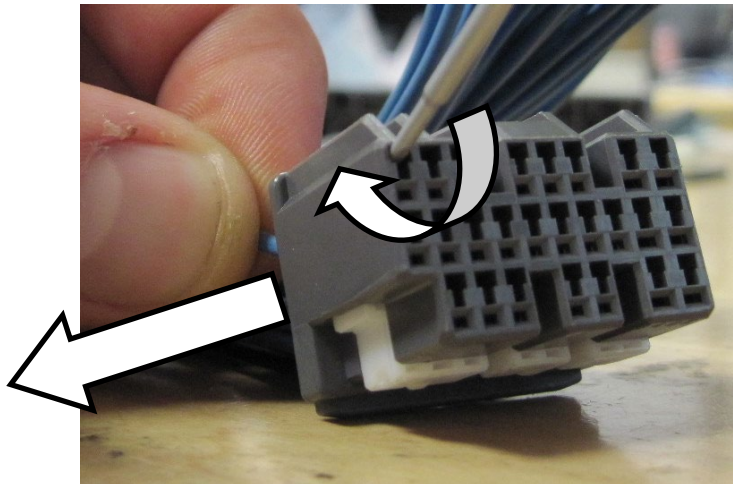
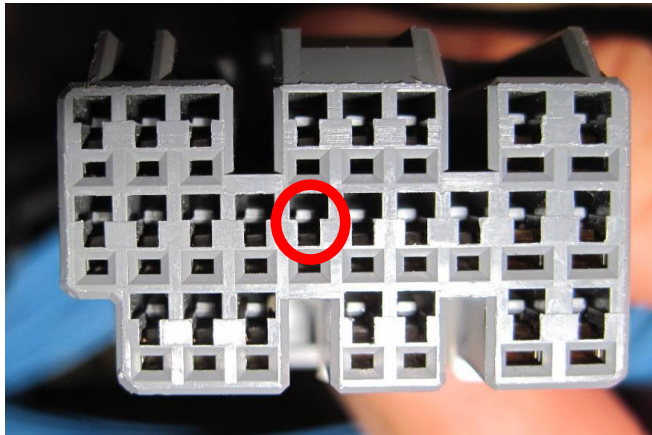

Figure above shows how plastic retainer will look when disengaged

- c) Next remove the metal pin from the plastic connector by lightly prying on the plastic tabs that secure the metal pin in the plastic connector while pulling on the wire at the same time as shown below. The first figure shows an example of the tab that must be pried up to disengage the pin.



4) Install the AEM Engine Management System

- a) Plug the factory wiring harness into the AEM EMS and position it so the wires are not pulled tight or stressed in any manner. Secure the EMS with the provided Velcro fasteners.
- b) Plug the comms cable into the EMS and into your PC.
- c) Turn the ignition on, but do not attempt to start the engine.
- d) At the time these instructions were written, new EMS units do not require USB drivers to be installed on the PC.
- e) With the AEMTuner software open, select **ECU>>Upload Calibration** to upload the startup calibration file (.cal) that most closely matches the vehicle's configuration to be tuned. Check the Notes section of the calibration for more info about the vehicle it was configured for. These files can be found in the following folder:
C:\Program Files\AEM\AEMTuner\Calibrations\Honda - Acura
- f) Set the throttle range: Select Wizards>>Set Throttle Range and follow the on-screen instructions. When finished, check that the 'Throttle' channel never indicates less than 0.2% or greater than 99.8%, this is considered a sensor error and may cause some functions including idle feedback and acceleration fuel to operate incorrectly.

5) Ready to begin tuning the vehicle.

- a) Before starting the engine, verify that the fuel pump runs for a couple of seconds when the key is turned on and there is sufficient pressure at the fuel rail.
If a MAP sensor is installed, check that the Engine Load indicates something near atmospheric pressure (approximately 101kPa or 0 PSI at sea level) with the key on and engine off. Press the throttle and verify that the 'Throttle' channel responds but the Engine Load channel continues to measure atmospheric pressure correctly.
- b) Start the engine and make whatever adjustments may be needed to sustain a safe and reasonably smooth idle. Verify the ignition timing: Select **Wizards>>Ignition Timing Sync** from the pull-down menu. Click the '*Lock Ignition Timing*' checkbox and set the timing to a safe and convenient value (for instance, 10 degrees BTDC). Use a timing light to compare the physical timing numbers to the timing value you selected. Use the *Sync Adjustment Increase/Decrease* buttons to make the physical reading match the timing number you selected.

Crankshaft timing marks are not labeled for some vehicles. Consult the factory service manual for more information. The diagram below shows labels for the Honda/Acura V6. A points to the timing indicator and B points to the 10° before top dead center mark.

**Ignition Timing:
10° BTDC (RED mark (B))**

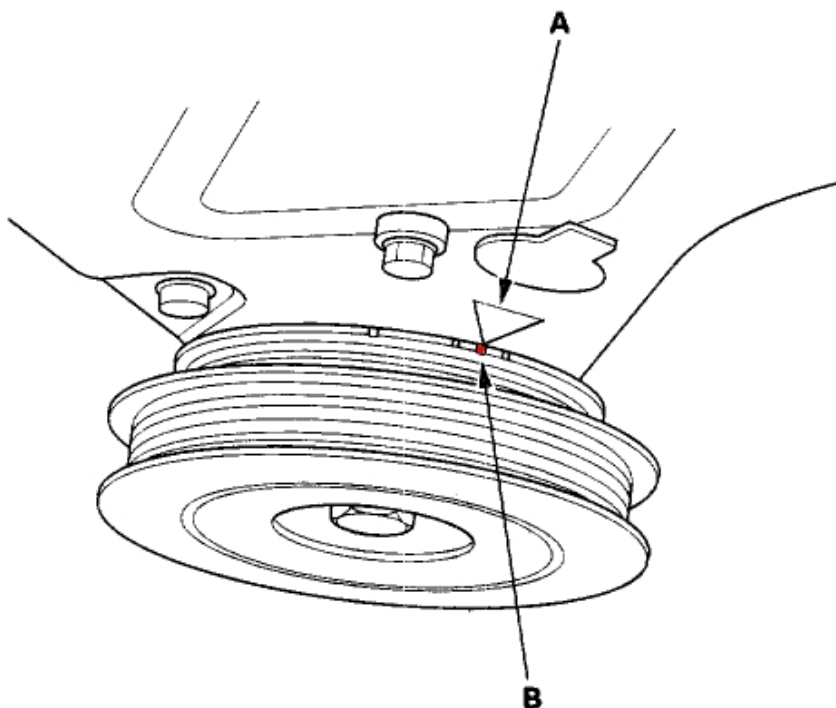

- c) Note: This calibration needs to be properly tuned before driving the vehicle. It is intended for racing vehicles and may not operate smoothly at idle or part-throttle. **NEVER TUNE THE VEHICLE WHILE DRIVING**

6) Troubleshooting an engine that will not start

- a) Double-check all the basics first... engines need air, fuel, compression, and a correctly-timed spark event. If any of these are lacking, we suggest checking simple things first. Depending on the symptoms, it may be best to inspect fuses, sufficient battery voltage, properly mated wiring connectors, spark using a timing light or by removing the spark plug, wiring continuity tests, measure ECU pinout voltages, replace recently-added or untested components with known-good spares. Check that all EMS sensor inputs measure realistic temperature and/or pressure values.
- b) If the EMS is not firing the coils or injectors at all, open the Start tab and look for the 'Stat Sync'd' channel to turn ON when cranking. This indicates that the EMS has detected the expected cam and crank signals; if Stat Sync'd does not turn on, monitor the Crank Tooth Period and T2PER channels which indicate the time between pulses on the Crank and T2 (Cam) signals. Both of these channels should respond when the engine is cranking, if either signal is not being detected or measuring an incorrect number of pulses per engine cycle the EMS will not fire the coils or injectors.
- c) If the Engine Load changes when the throttle is pressed this usually indicates that there is a problem with the MAP sensor wiring or software calibration (when the EMS detects that the MAP Volts are above or below the min/max limits it will run in a failsafe mode using the TPS-to-Load table to generate an artificial Engine Load signal using the Throttle input). This may allow the engine to sputter or start but not continue running properly.

Application Notes for EMS P/N 30-6051 J30A/A1, J32A1/A2, J35A4

Make:	Acura/Honda	Spare Injector Drivers:	Injector 12, Pin A10
Model:	Integra, 2.3CL, Accord, Civic	Spare Injector Drivers:	Injector 9, Pin A12
Years Covered:	1999-2004	Spare Injector Drivers:	Injector 11, Pin A14
Engine Displacement:	3.0L, 3.2L, 3.5L	Spare Injector Drivers:	Injector 8, Pin B16
Engine Configuration:	V6	Spare Injector Drivers:	Injector 10, Pin C11
Firing Order:	1-4-2-5-3-6	Spare Injector Drivers:	Injector 7, Pin D2
N/A, S/C or T/C:	N/A	Spare Coil Drivers:	Coil 7, Pin A13
Load Sensor Type:	MAP	Spare Coil Drivers:	Coil 8, Pin A22
MAP Min:	0.32V @ -13.9 psi	Boost Solenoid:	PW 2, Pin D16
MAP Max:	4.84V @ 10.94 psi	Spare PWM Freq Driver:	PW 3, Pin A11
# Coils:	6	EGT 1 Location:	Pin A5
Ignition driver type:	0-5V Falling Edge trigger	EGT 2 Location:	Pin D7
# of Injectors:	6 (Inj 1-6)	EGT 3 Location:	Pin A30
Factory Injectors:	240cc/min	EGT 4 Location:	Pin C5
Factory Inj Resistors:	No	Spare 0-5V Channels:	ADCR 11, Pin C6
Injection Mode:	Sequential	Spare 0-5V Channels:	ADCR 13, Pin C24
Knock Sensors used:	1 (Knock 1)	Spare 0-5V Channels:	ADCR 14, Pin D8
Lambda Sensors used:	2 (wideband sensors required, original O2 sensor not supported)	Spare Low Side Driver:	Low side 1, Pin A2
Idle Motor Type:	Duty-controlled solenoid	Spare Low Side Driver:	Low side 3, Pin A3
Main Relay Control:	No	Spare Low Side Driver:	Low side 5, Pin A4
Crank Pickup Type:	Magnetic (2-wire)	Spare Low Side Driver:	Low side 4, Pin A6
Crank Teeth/Cycle:	24	Spare Low Side Driver:	Low side 12, Pin A8
Cam Pickup Type:	Magnetic (2-wire)	Spare Low Side Driver:	Low side 6, Pin A17
Cam Teeth/Cycle:	3	Spare Low Side Driver:	Low side 7, Pin A19
Transmissions Offered:	Manual/Automatic	Spare Low Side Driver:	Low side 2, Pin C1
Trans Supported:	Manual	Check Engine Light:	Low side 10, Pin A18
Drive Options:	FWD	Spare High Side Driver:	High side 2, Pin B7
Supplied Connectors:	N/A	Spare High Side Driver:	High side 4, Pin D4
AEM Extension/patch harness	30-2982	Spare High Side Driver:	High side 3, Pin D13
AEM Plug/pin kit	35-2610	Spare Switch Input:	Switch 5, Pin A26
		Spare Switch Input:	Switch 1, Pin A32
		Spare Switch Input:	Switch 3, Pin D12
		A/C Switch Input:	Switch 6, Pin A27

Wire View of AEM EMS

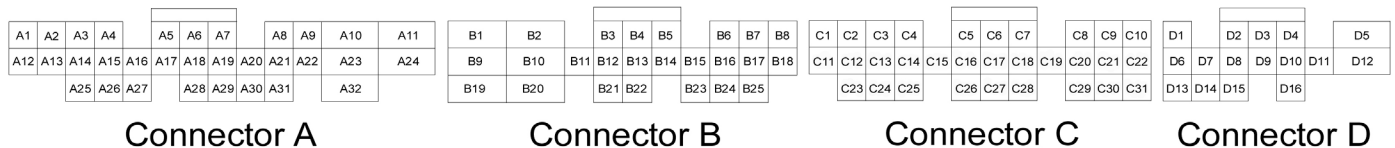

WARNING:

*All switch input pins must connect to ground; the switch should not provide 12V power to the EMS because that will not be detected as on or off.

Connection Diagram for EMS P/N 30-6051

PnP	Means the Plug and Play system comes with this configured for proper operation of this device. Is still available for reassignment by the end user.
Available	Means the function is not currently allocated and is available for use
Dedicated	Means the location is fixed and cannot be changed

Pin	1999-2002 Honda Accord V6 J30A1; 2002-2004 Honda Odyssey 3.5L V6 J35A4	1999-2003 Acura 3.2 TL/CL V6 J32A1; 2002-2003 Acura 3.2 TL/CL V6 Type S J32A2;	AEM EMS 30-6051	I/O	Notes
A1	Engine Coolant Temp (ECT) Gauge (1999 Honda Accord V6 J30A1); MTRTW serial signal (2000-2002 Honda Accord V6 J30A1);	Secondary heated O2 sensor	---	---	Not used
A2	Engine mount control solenoid	←	Low side 1	Output	Available, switched ground, 1.5A max
A3	EVAP bypass solenoid valve	←	Low side 3	Output	Available, switched ground, 1.5A max (set as reverse lockout in calibration)
A4	EVAP control canister vent shut	←	Low side 5	Output	Available, switched ground, 1.5A max
A5	Cruise control signal	←	EGT 1	Input	Available, jumper set for 0-5V input
A6	EVAP purge control solenoid	←	Low Side 4	Output	Available, switched ground, 1.5A max
A7	Reference voltage (2001-2002 Accord V6 J30A1 only)	Reference voltage (1999 Acura CL V6 J30A); Unterminated (2000-2003 Acura TL/CL V6 J32A1); Serial Data Line (2002-2003 Acura TL/CL V6 Type S J32A2)	Sensor +5V	Output	Dedicated, +5V sensor power output
A8	Secondary O2 heater control	←	Low side 12	Output	Available, switched ground, 1.5A max
A9	Vehicle speed output	←	Speedo freq signal	Output	PnP for speedometer signal to dashboard
A10	Service check signal	←	Injector 12	Output	Available, switched ground, 1.5A max
A11	A/T range switch (2001-2002 Accord V6 J30A1 only)	---	PW 3	Output	Available, PWM switched ground, 1.5A max
A12	Immobilizer indicator light	---	Injector 9	Output	Available, switched ground, 1.5A max
A13	Immobilizer enable signal (1999-2000 Honda Accord V6 J30A1 only);	SVC intake manifold runner control (2002-2003 Acura TL/CL V6 Type S J32A2 only)	Coil 7	Output	Available, 0/5V falling edge signal
A14	D4 indicator light (A/T)	D5 indicator light (A/T)	Injector 11	Output	Available, switched ground, 1.5A max
A15	Fuel pump relay	←	Low side 11	Output	PnP for fuel pump relay (connected to Pin A16)
A16	Immobilizer enable signal (2001-2002 Honda Accord V6 J30A1 only);	---	Low side 11	Output	Available, fuel pump relay (connected to Pin A15)

Wire View of AEM EMS

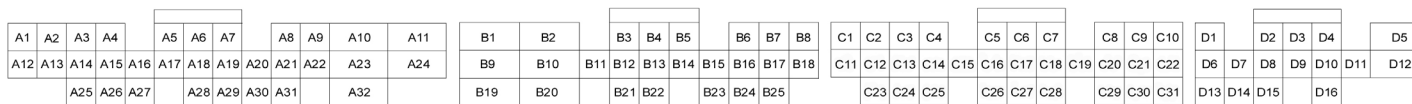

Connector A

Connector B

Connector C

Connector D

Connection Diagram for EMS P/N 30-6051

Pin	1999-2002 Honda Accord V6 J30A1; 2002-2004 Honda Odyssey 3.5L V6 J35A4	1999-2003 Acura 3.2 TL/CL V6 J32A1; 2002-2003 Acura 3.2 TL/CL V6 Type S J32A2;	AEM EMS 30-6051	I/O	Notes
A17	Air conditioner clutch relay	←	Low side 6	Output	Available, switched ground, 1.5A max
A18	Malfunction indicator light	←	Low side 10	Output	Available, switched ground, 1.5A max
A19	Engine speed pulse	←	Tach (Low side 7)	Output	PnP for tachometer
A20	Radiator fan control	←	Low side 8	Output	PnP for radiator fan control
A21	K-line	←	12 Vs	Output	Dedicated, +12V filtered power output
A22	Serial Data Line (2001-2002 Honda Accord V6 J30A1 only)	Serial Data Line (2002-2003 Acura TL/CL V6 Type S J32A2 only)	Coil 8	Output	Available, 0/5V falling edge signal
A23	Secondary O2 sensor (1999-2002 Honda Accord V6 J30A1 only)	---	O2 #2	Input	PnP for O2 sensor #2 (connected to C15)
A24	Starter switch signal	←	Ignition switch	Input	Dedicated, +12V input to EMS
A25	Immobilizer code (1999-2002 Honda Accord V6 J30A1 only)	---	Idle 3	Output	Available, switched ground, 1.5A max
A26	Power steering pressure switch	←	Switch 5	Input	Available, switched input
A27	Air conditioner switch input	←	Switch 6	Input	Available, switched input
A28	ILU (to multiplex control unit)	←	Idle 2	Output	Available, switched +12V, 1.5A max
A29	Fuel tank pressure sensor	←	MAF	Input	Available, 0-5V input
A30	Electrical load detector	←	EGT 3	Input	Available, jumper set for 0-5V input
A31	TPS output signal (A/T) (2001-2002 Honda Accord V6 J30A1 only); ECT output signal (2002-2004 Honda Odyssey V6 J35A4 only)	ECT output signal (2002-2003 Acura TL/CL V6 Type S J32A2 only)	Sensor ground	Output	Available, sensor ground
A32	Brake switch signal	←	Switch 1	Input	Available, switched input

Wire View of AEM EMS

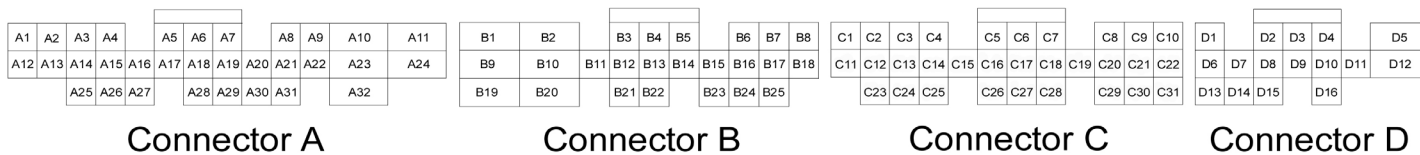

Connection Diagram for EMS P/N 30-6051

Pin	1999-2002 Honda Accord V6 J30A1; 2002-2004 Honda Odyssey 3.5L V6 J35A4	1999-2003 Acura 3.2 TL/CL V6 J32A1; 2002-2003 Acura 3.2 TL/CL V6 Type S J32A2;	AEM EMS 30-6051	I/O	Notes
B1	Ignition Power 1	←	Ignition power	Input	Dedicated, +12V input to EMS
B2	Power Ground 1	←	Power ground	Input	Dedicated, ground input to EMS
B3	Cylinder 5 injector	←	Injector 2	Output	PnP for cylinder 5 injector (injector 2 in calibration)
B4	Cylinder 4 injector	←	Injector 3	Output	PnP for cylinder 4 injector (injector 3 in calibration)
B5	Cylinder 2 injector	←	Injector 4	Output	PnP for cylinder 2 injector (injector 4 in calibration)
B6	Cylinder 6 injector	←	Injector 6	Output	PnP for cylinder 6 injector (injector 6 in calibration)
B7	EGR valve	←	High side 2	Output	Available, switched +12V output, 1.5A max
B8	A/T clutch pressure valve A-	←	Idle 5	Output	Available, switched ground, 1.5A max
B9	Ignition Power 2	←	Ignition power	Input	Dedicated, +12V input to EMS
B10	Power Ground 2	←	Power ground	Input	Dedicated, ground input to EMS
B11	Injector 1	←	Injector 1	Output	PnP for cylinder 1 injector (injector 1 in calibration)
B12	VTEC solenoid valve	←	High side 1	Output	PnP for VTEC solenoid valve output signal
B13	Ignition control module (1999 Honda Accord V6 J30A1 only); A/T clutch pressure valve C+ (2002-2004 Honda Odyssey V6 J35A4 only)	A/T clutch pressure valve C+	Coil 1	Output	Available, coil 1 0/5V falling edge signal (connected to C1)
B14	2nd clutch pressure switch (1999 Honda Accord V6 J30A1 only); Park switch (all others)	Park switch	---	---	Not used
B15	Cylinder 3 injector	←	Injector 5	Output	PnP for injector 3, switched ground (connected to D1)
B16	---	---	Injector 8	Output	Available, switched ground, 1.5A max
B17	A/T clutch pressure valve A+	←	Idle 6	Output	Available, switched +12V, 1.5A max
B18	A/T clutch pressure valve B-	←	Idle 7	Output	Available, switched ground, 1.5A max
B19	4th oil pressure switch (2002-2004 Honda Odyssey V6 J35A4 only)	4th oil pressure switch	Injector 6	Output	Available, Injector 6 switched ground, 1.5A max (connected to B6)
B20	Logic ground 1	←	Power ground	Input	Dedicated, ground input to EMS
B21	Voltage back-up	←	Permanent 12V	Input	Dedicated, +12V input to EMS
B22	Logic ground 2	←	Power ground	Input	Dedicated, ground input to EMS
B23	Idle air control valve	←	PW 1	Output	PnP for idle air control valve
B24	3rd clutch pressure switch	←	Knock sensor 2	Input	Available, knock sensor 2
B25	A/T clutch pressure valve B+	←	Idle 8	Output	Available, switched +12V, 1.5A max

Wire View of AEM EMS

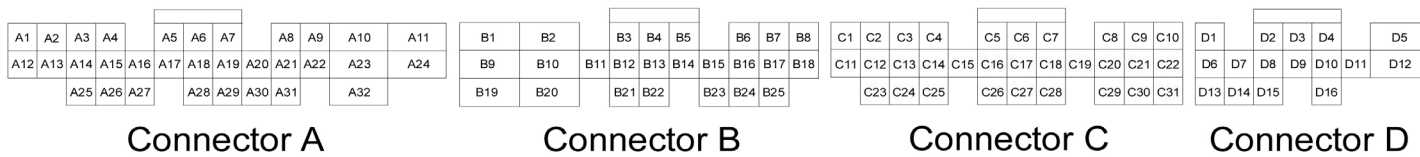

Connection Diagram for EMS P/N 30-6051

Pin	1999-2002 Honda Accord V6 J30A1; 2002-2004 Honda Odyssey 3.5L V6 J35A4	1999-2003 Acura 3.2 TL/CL V6 J32A1; 2002-2003 Acura 3.2 TL/CL V6 Type S J32A2;	AEM EMS 30- 6051	I/O	Notes
C1	Primary O2 heater control	←	Low side 2	Output	Available, switched ground, 1.5A max
C2	Alternator C	←	---	---	Not used
C3	Cylinder 3 coil	←	Coil 5	Output	PnP for cylinder 3 coil (uses coil 5 in calibration), 0/5V falling edge signal
C4	Cylinder 1 coil	←	Coil 1	Output	PnP for cylinder 1 coil, 0/5V falling edge signal
C5	Alternator F	←	EGT 4	Input	Available, jumper set for 0-5V input
C6	EGR valve lift sensor	←	ADCR11	Input	Available, 0-5V input
C7	Sensor ground 1	←	Sensor ground	Output	Dedicated, sensor ground output
C8	CKP +	←	Crank sensor signal	Input	Dedicated, crank position sensor input
C9	CKP -	←	Crank sensor ground	Output	Dedicated, crank position sensor ground output
C10	VTEC pressure switch signal	←	Switch 4	Input	PnP for VTEC oil pressure switch
C11	---	---	Injector 10	Output	Available, switched ground, 1.5A max
C12	Cylinder 5 coil	←	Coil 2	Output	PnP for cylinder 5 coil (uses coil 2 in calibration), 0/5V falling edge signal
C13	Cylinder 4 coil	←	Coil 3	Output	PnP for cylinder 4 coil (uses coil 3 in calibration), 0/5V falling edge signal
C14	Cylinder 2 coil	←	Coil 4	Output	PnP for cylinder 2 coil (uses coil 4 in calibration), 0/5V falling edge signal
C15	---	---	O2 #2	Input	Available, 0-5V O2 sensor #2 input (connected to A23)
C16	Primary O2 sensor	←	O2 #1	Input	PnP, 0-5V O2 sensor #1 input
C17	MAP sensor	←	MAP	Input	PnP, 0-5V MAP sensor input
C18	Sensor ground 2	←	Sensor ground	Output	Dedicated, sensor ground output
C19	Sensor voltage 1	←	Sensor +5V	Output	Dedicated, sensor +5V output
C20	TDC1+	←	Cam sensor signal	Input	Dedicated, cam sensor input (T2)
C21	TDC1-	←	Cam sensor ground	Output	Dedicated, cam sensor ground output
C22	Knock Sensor (2002-2004 Honda Odyssey V6 J35A4 only)	Knock sensor	Knock sensor 1	Input	PnP for knock sensor 1
C23	Cylinder 6 coil	←	Coil 6	Output	PnP for cylinder 6 coil (uses coil 6 in calibration), 0/5V falling edge signal
C24	ATF temperature sensor (2002-2004 Honda Odyssey V6 J35A4 only)	ATF temperature sensor	ADCR13	Input	Available, 0-5V input, 100Kohm pull up resistor to +5V
C25	Intake air temperature sensor	←	AIT	Input	PnP for intake air temperature sensor
C26	Engine coolant temperature sensor	←	Coolant	Input	PnP for engine coolant temperature sensor
C27	Throttle position sensor	←	TPS	Input	PnP for throttle position sensor
C28	Sensor voltage 2	←	Sensor +5V	Output	Dedicated, sensor +5V output
C29	TDC2+	←	Spare speed (T4)	Input	Available, spare speed sensor
C30	TDC2-	←	Timing ground	Output	Available, spare speed sensor ground
C31	---	---	Timing ground	Output	Available, spare speed sensor ground

Wire View of AEM EMS

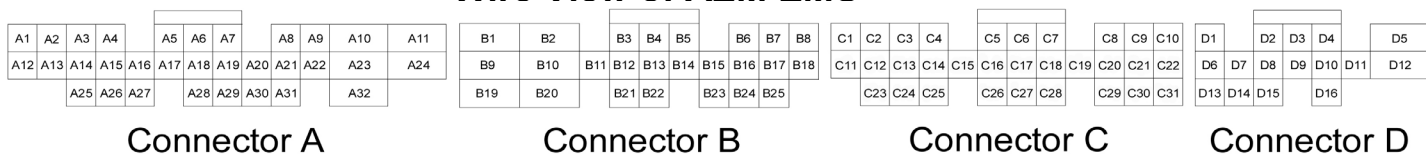

Connection Diagram for EMS P/N 30-6051

Pin	1999-2002 Honda Accord V6 J30A1; 2002-2004 Honda Odyssey 3.5L V6 J35A4	1999-2003 Acura 3.2 TL/CL V6 J32A1; 2002-2003 Acura 3.2 TL/CL V6 Type S J32A2;	AEM EMS 30-6051	I/O	Notes
D1	Lock-up control solenoid valve	←	Injector 5	Output	Available, switched ground, 1.5A max (connected to B15)
D2	Shift control solenoid valve B	←	Injector 7	Output	Available, switched ground, 1.5A max
D3	Shift control solenoid valve C	←	Idle 1	Output	Available, switched ground, 1.5A max
D4	---	A/T gear position switch signal	High side 4	Output	Available, switched input
D5	Battery flyback solenoid	←	Idle 4	Output	Available, switched +12V, 1.5A max
D6	A/T reverse switch	←	Sensor +5V	Output	Available, sensor +5V output
D7	Shift control solenoid valve A	←	EGT 2	Input	Available, jumper set for 0-5V input
D8	A/T D3 sw	A/T D4 sw	ADCR14	Input	Available, 0-5V input, 100Kohm pull up resistor to +5V
D9	A/T D4 sw (1999-2002 Honda Accord V6 J30A1); A/T D5 sw (2002-2004 Honda Odyssey V6 J35A4)	A/T D5 sw	Sensor ground	Output	Available, sensor ground output
D10	Countershaft speed sensor +	←	CAN1H	---	Dedicated, CAN high side
D11	Mainshaft speed sensor +	←	Vehicle Speed (T3)	Input	PnP for vehicle speed sensor input
D12	Mainshaft speed sensor -	←	Switch 3	Input	Available, switched +12V input, 1.5A max
D13	Park switch (1999 Honda Accord V6 J30A1); 2nd clutch pressure switch (2000 Honda Accord V6 J30A1);	3rd oil pressure switch	High side 3	Output	Available, switched +12V output, 1.5A max
D14	A/T 2 sw	A/T 3 sw	CAN1L	---	Dedicated, CAN low side
D15	A/T 1 sw	A/T 2 sw	Baro Volts	Input	Available, 0-5V input
D16	Countershaft speed sensor -	←	PW 2	Output	Available, boost solenoid output

Wire View of AEM EMS

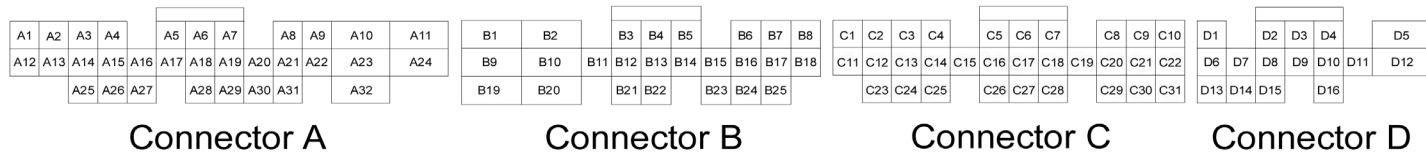

AEM Electronics Warranty

Advanced Engine Management Inc. warrants to the consumer that all AEM Electronics products will be free from defects in material and workmanship for a period of twelve months from date of the original purchase. Products that fail within this 12-month warranty period will be repaired or replaced when determined by AEM that the product failed due to defects in material or workmanship. This warranty is limited to the repair or replacement of the AEM part. In no event shall this warranty exceed the original purchase price of the AEM part nor shall AEM be responsible for special, incidental or consequential damages or cost incurred due to the failure of this product. Warranty claims to AEM must be transportation prepaid and accompanied with dated proof of purchase. This warranty applies only to the original purchaser of product and is non-transferable. All implied warranties shall be limited in duration to the said 12-month warranty period. Improper use or installation, accident, abuse, unauthorized repairs or alterations voids this warranty. AEM disclaims any liability for consequential damages due to breach of any written or implied warranty on all products manufactured by AEM. Warranty returns will only be accepted by AEM when accompanied by a valid Return Merchandise Authorization (RMA) number. Product must be received by AEM within 30 days of the date the RMA is issued.

Please note that before AEM can issue an RMA for any electronic product, it is first necessary for the installer or end user to contact the tech line at 1-800-423-0046 to discuss the problem. Most issues can be resolved over the phone. Under no circumstances should a system be returned or a RMA requested before the above process transpires.

AEM will not be responsible for electronic products that are installed incorrectly, installed in a non approved application, misused, or tampered with.

Any AEM electronics product can be returned for repair if it is out of the warranty period. There is a minimum charge of \$75.00 for inspection and diagnosis of AEM electronic parts. Parts used in the repair of AEM electronic components will be extra. AEM will provide an estimate of repairs and receive written or electronic authorization before repairs are made to the product.